

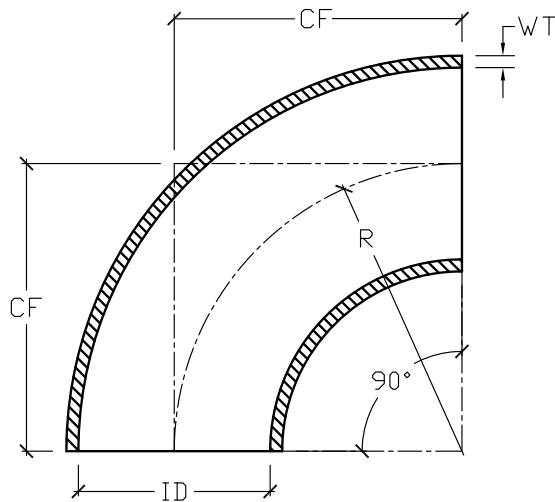

FRP 90° ELBOW
4" DIAMETER
150 PSI



NOMINAL INSIDE DIAMETER [ID]	PRESSURE RATING PSI	WALL THICKNESS [WT]	CENTERLINE TO FACE HEIGHT [CF]
4"	150	1/4"	6"

Information appearing in this literature is provided as a guide for the use and application of the products being offered. It is not and does not represent a specific warranty or guarantee of the product or its performance. It is the user's responsibility to determine the suitability of this product for a specific application.

