

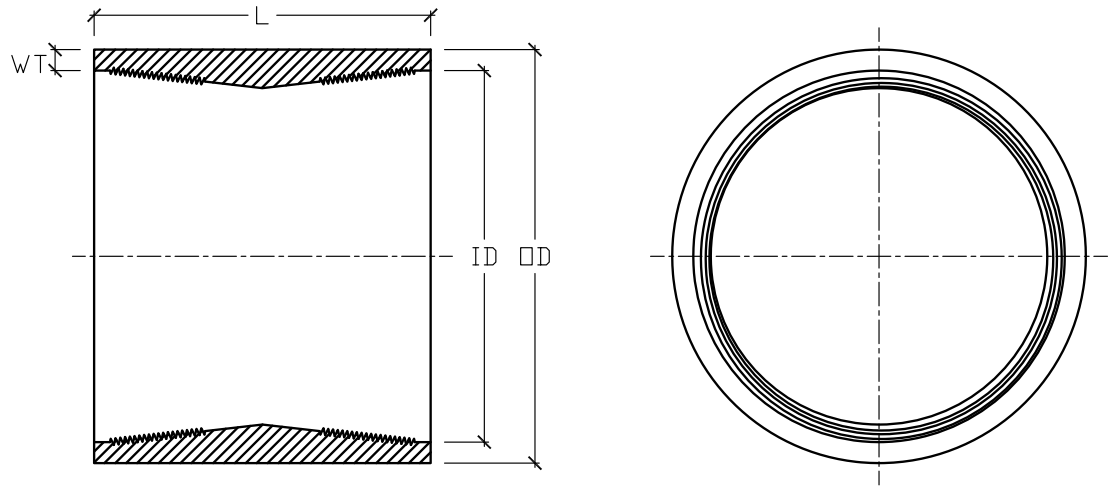

FRP COUPLING
 4" DIAMETER
 8" LENGTH
 150 PSI



NOMINAL INSIDE DIAMETER [ID]	PRESSURE RATING PSI	OUTSIDE DIAMETER [OD]	OVERALL LENGTH [L]	WALL THICKNESS [WT]
4"	150	5"	8"	1/2"

Information appearing in this literature is provided as a guide for the use and application of the products being offered. It is not and does not represent a specific warranty or guarantee of the product or its performance. It is the user's responsibility to determine the suitability of this product for a specific application.

