

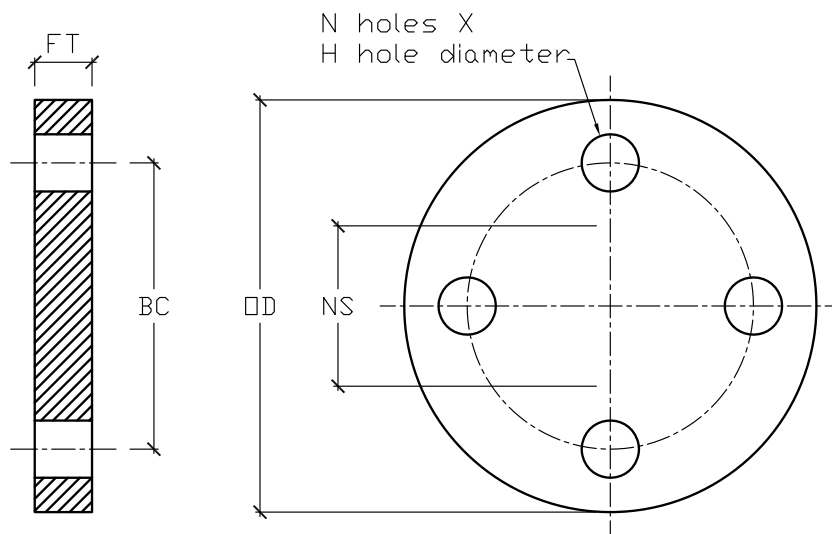

FRP BLIND FLANGE
1" DIAMETER
150 PSI



NOMINAL SIZE [NS]	PRESSURE RATING PSI	FLANGE THICKNESS [FT]	OUTSIDE DIAMETER [OD]	BOLT CIRCLE DIAMETER [BC]	NUMBER OF HOLES [N]	BOLT HOLE DIAMETER [H]
1"	150	11/16"	4-1/4"	3-1/8"	4	5/8"

Information appearing in this literature is provided as a guide for the use and application of the products being offered. It is not and does not represent a specific warranty or guarantee of the product or its performance. It is the user's responsibility to determine the suitability of this product for a specific application.

